

NOVAH

MOLO

conference tables



MOLO

无限延伸，持续进化的活性家具
Incredibly extends space and time



Endless Support

支持你的无限可能 ∞

"Molo" in Italy either means pier or dock, a term apt for the purpose of this innovative conference table system. Like a pier with a bridge supported by pillars, the MOLO conference table is supported by sturdy legs that hold the platform together enabling people to communicate and work well together.

“MOLO”本意为意大利语中的“桥墩”，自古以来关联并支撑着人们的生活。MOLO 会议桌系统，拥有卓越的延展性，为人们搭建沟通互动的桥梁。

MOLO

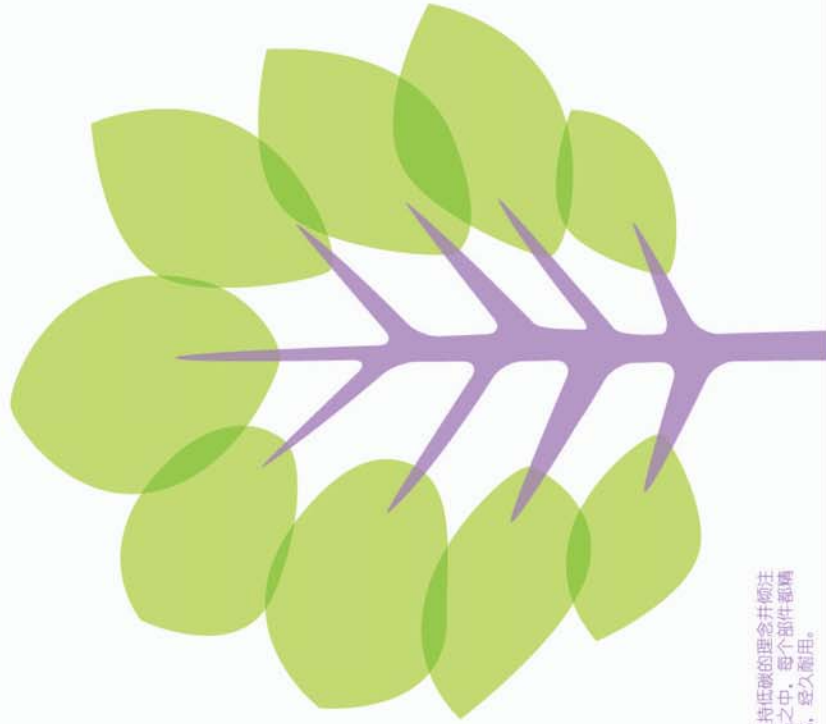

公司始终坚持低碳的理念并倾注到每件产品之中，每个部件都精心打造而成，经久耐用。

Every component is manufactured with precision and checked for quality, made to last. Special attention is given to the manufacturing process, minimizing carbon footprint and to be environmental friendly.

MOLO is manufactured with the use of recycled steel, aluminum and plastic making it a sustainable product.

MOLO 的设计是在保护环境、可回收利用的基础上进行的，包括使用钢、铝、塑料等可回收材料，易拆解的特性也使得产品利用率更高。

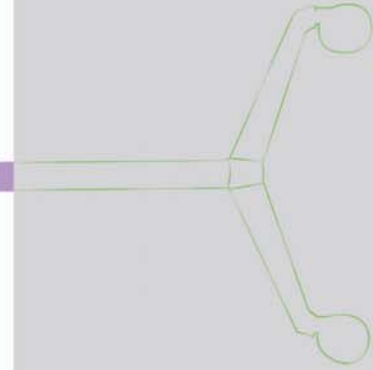

Simple and light
简约轻巧



Available in multiple specifications to fit your needs
多种规格选择



Choice of multiple supporting colors
多种颜色选择



Easily dismantled for storage
可折叠存放



Infinitely extendable
无限延伸



The form of a variety of legs
多种桌腿形式



Conveniently mobile
方便滑行 / 定位的脚轮

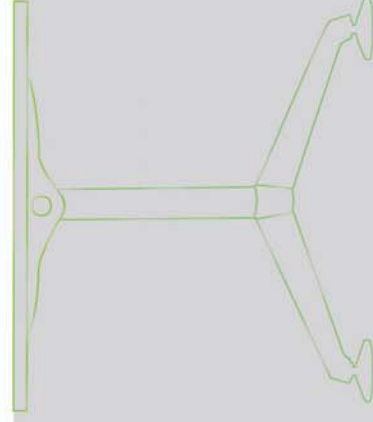

Conference tables

迎合各项需求 网聚人的力量

Embracing your most ordinary needs,
to create extraordinary synergy in your team.

The MOLO series is a modern, flexible and multifunctional conference table system. It can serve many purposes in an office area.

MOLO 会议桌系统为商业环境提供了一个灵活、舒适、多变、多功能的桌子使用系统，产品风格全面而丰富。

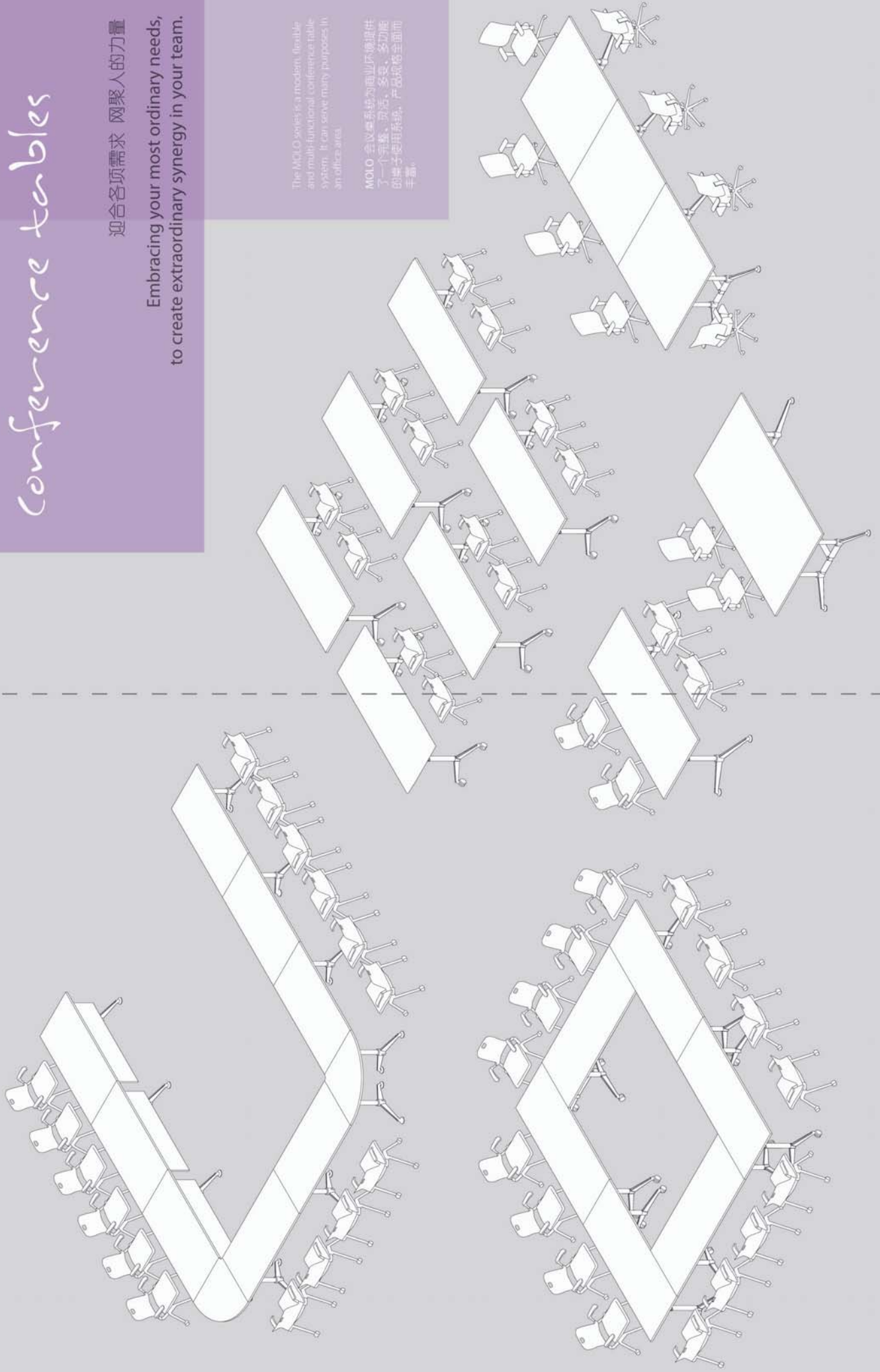

Intelligent 智能

对我来说意味着
在有限的空间里节省空间

It provides a limited space
countless options.



Training tables

变化多端，灵巧自如，
为办公环境带来无限可能。

Dynamic, flexible and efficient,
providing endless possibilities
to an office space.



Lever down for
castor lock, Lever
up to free castor.

把手杆往下拉来
锁定轮子。提起
到杆，轮子将解
解锁可滑动。



MOLO more conference table with the
paddle to choose from.
更具有含挡板的MOLO会议桌可供选择。



580 base

桌板规格：
W1500xD600 (2人)
W1500xD700 (2人)
W1800xD600 (3人)
W1800xD700 (3人)

桌脚规格：
W140xD580
W1740xD580

740 base

桌板规格：
W1500xD800 (4人)
W1500xD900 (4人)
W1800xD800 (6人)
W1800xD900 (6人)

桌脚规格：
W1483xD740
W1783xD740

training room

培训室



Suitable for any environment to satisfy your needs.

情境所需，随心所欲。

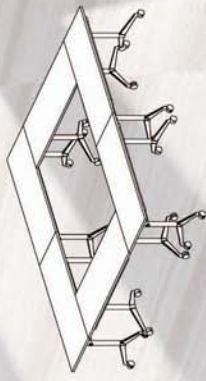
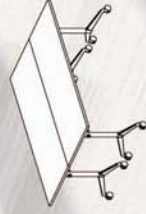
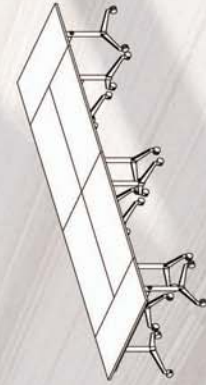

conference tables

未来是一道坦途，
前面有着无限憧憬。

The future is ours to hold.
We can make our dream into reality.

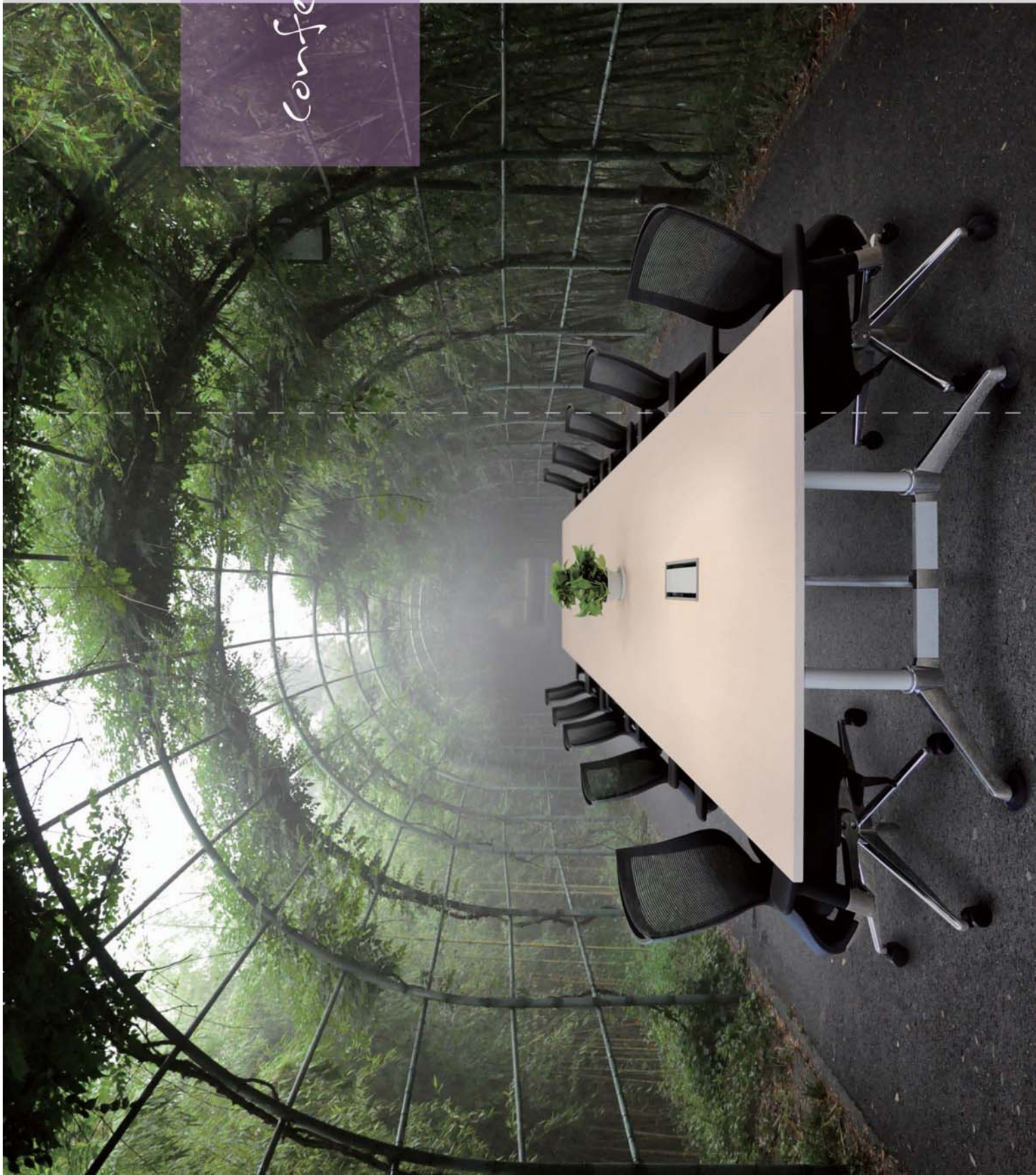

Conference tables

桌组系统的组合丰富多样，无论是大型抑或小型的会议环境，皆可随心所欲，满足多样的需求。

This system can increase table units to fit your office space requirements.

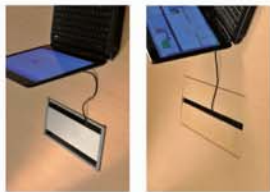

The MOLO specified cable box helps prevent dust clustering over messy cable routes.

桌面可选择MOLO专用线盒，避免因线路灰尘堆积而所造成的视觉瑕疵。关注细节，力求每一个细微之精益求精，营造完美办公新体验。

MOLO

Limitless

无限大

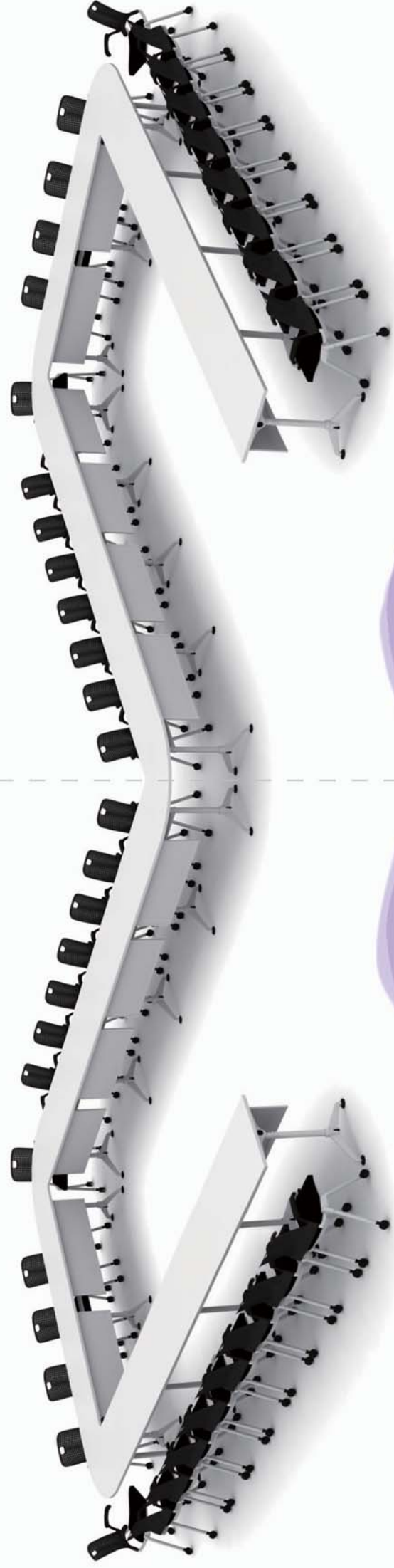

Reconfigurable meeting tables

环形会议桌

Legzits are ready to be dismantled. Choice of different table dimensions available. MCOLO can be infinitely extended through the use of the linking leg frame system. Choice available to install modesty panel and cable management baskets.

腿架可拆卸安装而取，可设置不同尺寸。MCOLO 可通过连接腿架系统无限延伸。可选择安装挡板和线缆收纳架。

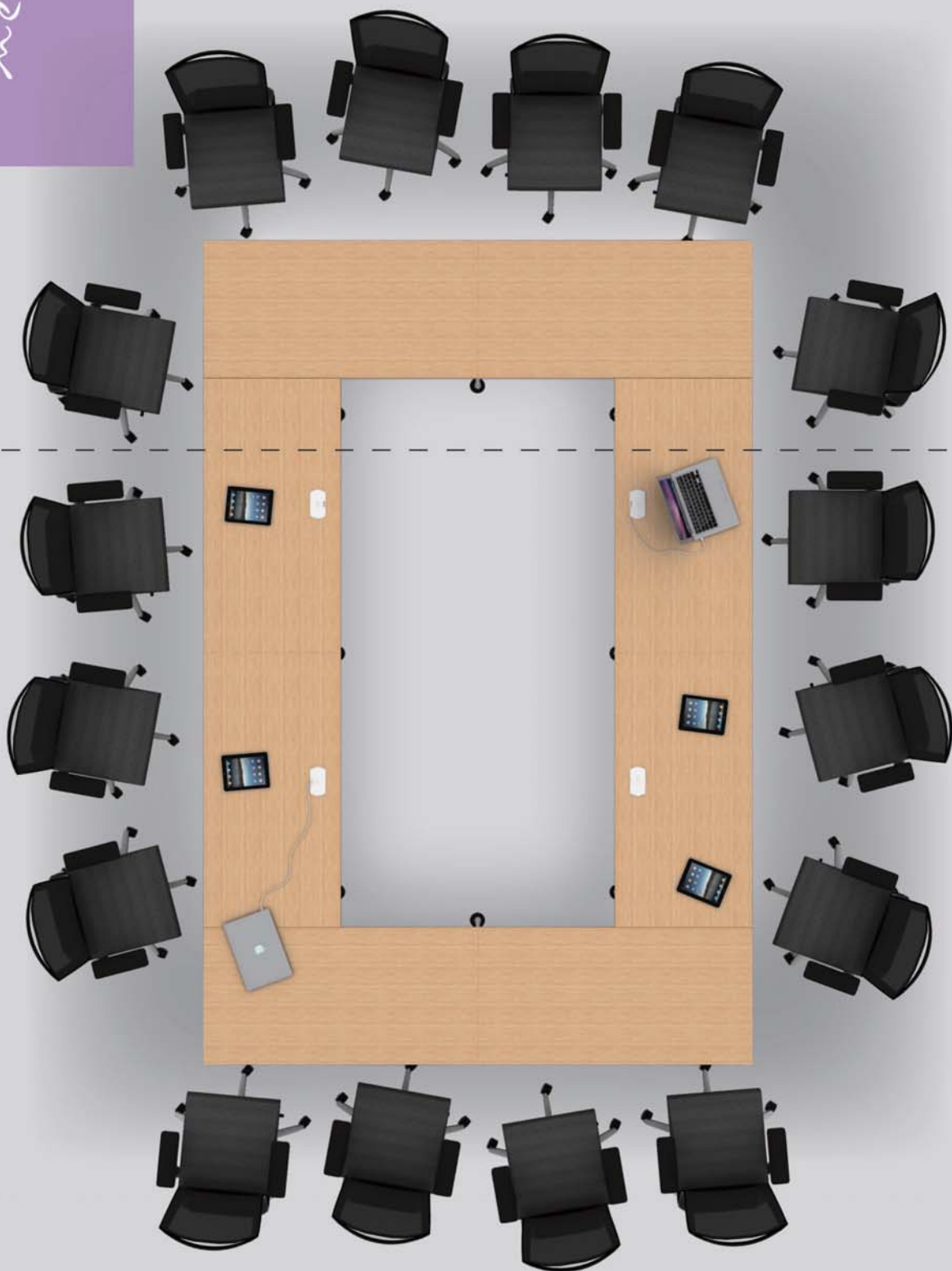

Round tables



Strong endurance and chic.

缘起于圆，无须彰显
即有非凡的气度和灵动。



圓形的台面，方便溝通交流。賦予辦公室更多生機和活力。不同規格，滿足洽談、辦公場合等多種需求。

Circular table surface enables easy communication and brings more energy and life into your office environment. Available in different specifications to different functions such as private meetings or public area needs.



The MOLO system offers full functionality through its wide range of frame configurations.

各种不同的脚架拼接方式，衍生出功能齐全的MOLO系列。



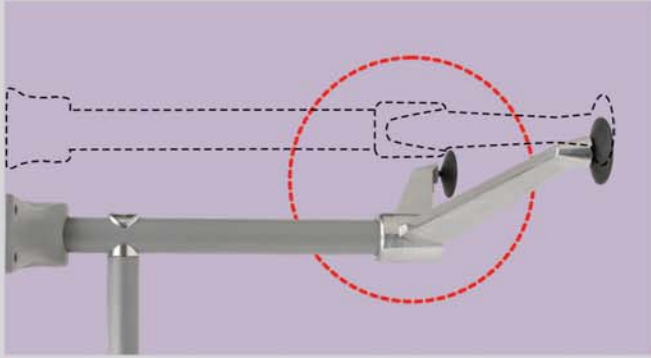

单柱会议桌脚
适用桌板宽度 D900-1000mm
Single column meeting table leg, suitable for table length of dimensions 900-1000mm

双柱会议桌脚
适用桌板宽度 D1400mm
Dual column meeting table leg, suitable for table length of dimensions 1400mm



可左右转动，调节高度，达到桌面的平衡。
Sideways adjustable, Height adjustable, to achieve table surface balance.

Structure is the basis of everything!
结构，一切的基础！

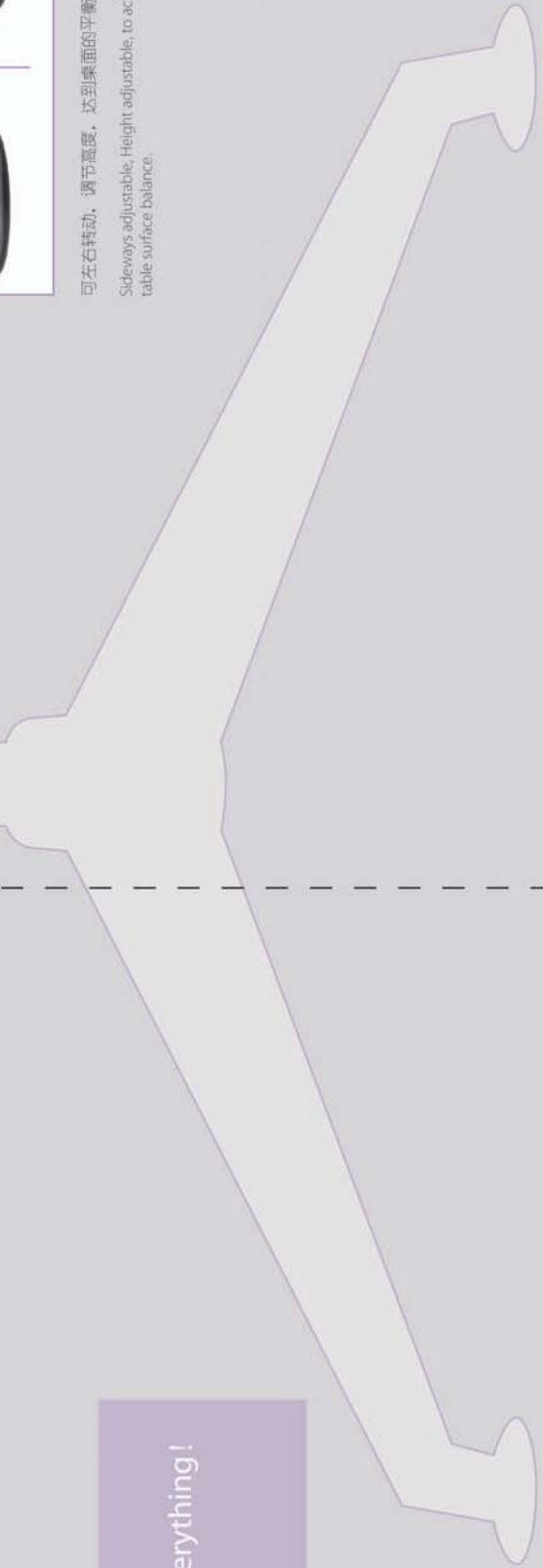

A color collection is available to choose from.
恣意挥洒，MOLO的色彩系统



实木贴面



MFC: M1-19
实木贴面：
W2/4/5/6/8/9/10/12/13/15/16/18/19
桌板可选配MOLO专用铝制双翻线
盒或毛刷双翻线盒，MFC板厚
25mm，实木贴面板厚30mm。（侧面
为斜切面）

MFC: M1-M19
Wood Veneer:
W2/4/5/6/8/9/10/12/13/15/16/18/19
Table can be fitted with specified
aluminum dual flip
cable box or dual flip brushed cover
cable box.
MFC board Thickness: 25mm
Veneered finished board thickness:
30mm

MFC

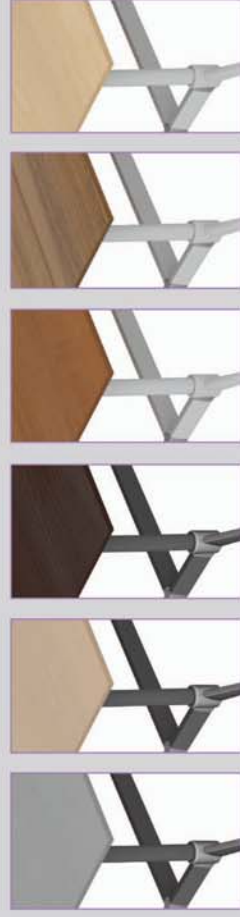

Specification

规格尺寸

MOLO折叠桌 (A脚)

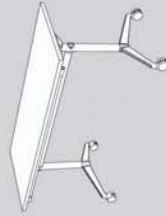

桌板规格:
W1500×D600
W1500×D700
W1800×D600
W1800×D700

桌脚规格:
W1440×D580
W1740×D580

MOLO折叠桌 (A脚 配挡板)

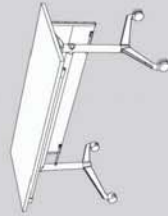

桌板规格:
W1500×D600
W1500×D700
W1800×D600
W1800×D700

桌脚规格:
W1440×D580
W1740×D580

MOLO折叠桌 (B脚)

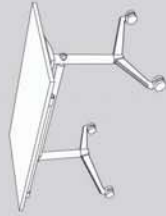

桌板规格:
W1500×D800
W1500×D900
W1800×D800
W1800×D900

桌脚规格:
W1483×D740
W1783×D740

MOLO圆形会议桌 (E脚)

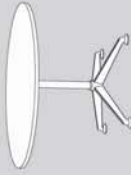

桌板规格:
Ø900×D750/755
Ø1000×D750/755
Ø1200×D750/755

桌脚规格:
Ø680×D680

MOLO圆形会议桌 (F脚)



桌板规格:
Ø1400×D750/755
Ø1500×D750/755
Ø1600×D750/755
Ø1800×D750/755

桌脚规格:
Ø1380×D1380

MOLO椭圆形会议桌 (D脚)

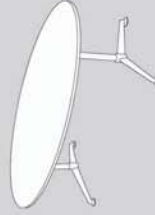

桌板规格:
W1800×D1000
W2100×D1100
W2400×D1200

桌脚规格:
W1190×D850
W1490×D850
W1790×D850

MOLO椭圆形会议桌 (D脚)



组合桌板规格:
W3000×D1200
W3200×D1200
W3400×D1200

桌脚规格:
W2390×D880
W2590×D880
W2790×D880

MOLO组合型矩形桌 (F脚)



桌板规格:
W2400×D1400

桌脚规格:
W2254×D1360

MOLO矩形会议桌 (F脚)



组合桌板规格:
W2800×D1400
W3000×D1400
W3200×D1400

桌脚规格:
W2654×D1360
W2854×D1360
W3054×D1360

MOLO矩形会议桌 (F脚)



组合桌板规格:
W3600×D1400
W4200×D1400
W4800×D1400

桌脚规格:
W3454×D1360
W4054×D1360
W4654×D1360

MOLO矩形会议桌 (D脚)



桌板规格:
W1800×D900
W2000×D900
W2200×D1000
W2400×D1000

桌脚规格:
W1450×D850
W1650×D850
W1850×D850
W2050×D850

MOLO弧形会议桌 (C脚 配挡板)

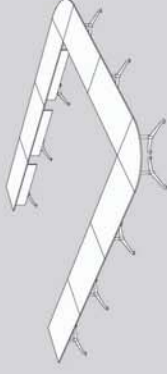

方形桌板规格:
W1200×D600
W1400×D600
W1600×D600
W1800×D600
W1200×D700
W1400×D700
W1600×D700
W1800×D700

弧形桌板规格:
W650×D650
W750×D750

MOLO弧形会议桌 (C脚)

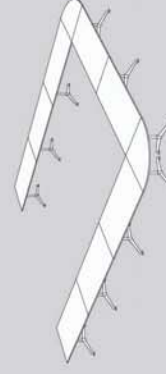

方形桌板规格:
W1200×D600
W1400×D600
W1600×D600
W1800×D600
W1200×D700
W1400×D700
W1600×D700
W1800×D700

弧形桌板规格:
W650×D650
W750×D750

MOLO

Conference tables

SHANGHAI (HEAD OFFICE)

Tel: 86 21 6495 5388

Fax: 86 21 6495 9666

3F, Building 8#, 456 Hongcao Rd., Xuhui District, Shanghai, 200233

上海市徐汇区虹漕路456号8号楼3层

SHANGHAI (R&D + Operation + Manufacturing)

Tel: 86 21 3756 6628

Fax: 86 21 3756 6791

228Xihan Rd., Shanghai Fengpu Industrial Park Export Processing Zone, 201400

上海市工业综合开发区(奉贤)西韩路228号

BEIJING BRANCH

Tel: 86 10 6553 9907

Fax: 86 10 6552 9366

2F, Jiahui Building, 6 Jiqingli, Chaoyang District, Beijing, 100020

北京市朝阳区朝外大街吉庆里6号佳汇中心2层

SHENZHEN BRANCH

Tel: 86 755 2399 3310

Fax: 86 755 3309 6265

9/F, Building B, Xuesong Mansion, 6 Tairan Rd., Futian District, Shenzhen, 518000

深圳市福田区泰然六路雪松大厦B幢9层

NANJING BRANCH

Tel: 86 25 8451 7001

Fax: 86 25 8451 4990

2F, 81-1 Huaqiao Rd., Gulou District, Nanjing, 210029

南京市鼓楼区华侨路81-1号2层

JINAN BRANCH

Tel: 86 531 8651 6588

Fax: 86 531 8651 6771

The eastern of central plaza, Building C, QiLu Software Park,

GaoXin High-tech Industrial Development Zone, JiNan, 250101

济南市高新区齐鲁软件园C座中心广场东首

NINGBO BRANCH

Tel: 86 574 2883 7214

Fax: 86 574 2883 7224

8F, Building 4#, R&D Garden, 999 Yangfan Rd., Gaoxin District, Ningbo, 315048

宁波市高新区扬帆路999弄研发园4号楼8F

www.novah.cc



MOLO trademarks and images belong to the Novah (Shanghai) Office Systems Co., Ltd. All rights reserved.

MOLO 商标和图片属于诺梵(上海)办公系统有限公司版权所有